



Photo 43 446

FIG 1 FSP (front, as cabinet for portable use) is approaching high-end units (FSE and FSIQ in background) in performance

Spectrum Analyzer FSP Medium class aspiring to high end

Playing right at the top of the high-end class are Spectrum Analyzers FSE and Signal Analyzers FSIQ from Rohde & Schwarz. After all, their RF performance, measurement speed and accuracy plus flexibility make them suitable for even the most demanding applications. New on the scene are the attractively priced Spectrum Analyzers FSP (FIG 1) that, although medium class, are able to offer similar performance. And in some respects they even outdo the top performers.

High measurement accuracy combined with high speed

With its high measurement speed and accuracy, FSP is not only the right tool for general-purpose laboratory and service applications but also an ideal choice for production needs. Speed and accuracy are decisive for throughput and for investment in measuring equipment for a given production target. To significantly improve these key features, Rohde & Schwarz took a completely new approach in the design of FSP, making it fit for in-production measurements, for example on components and modules of radio transmission equipment, with maximum speed and reproducibility.

The basic prerequisite for high measurement throughput is high-speed remote control. A normal benchmark test determines the number of traces transmit-

ted per second to a controller on the remote interface. FSP is fitted with an IEC/IEEE-bus interface as standard. With 10 MHz span and minimum sweep time it transmits up to 30 traces with 501 test points per trace. In the zero span mode, as many as 70 traces per second are possible. In manual operation, up to 25 pictures per second create the impression of an analog measurement and enable speedy alignment.

The FSP family comprises four analyzers with different frequency ranges:

FSP3	9 kHz	to	3 GHz
FSP7	9 kHz	to	7 GHz
FSP13	9 kHz	to	13 GHz
FSP30	9 kHz	to	30 GHz

Thus optimum frequency range can be offered for each application, whether RF or microwave.

Synthesizer set in next to no time

A VCO works as the first local oscillator. This offers considerably higher speed than the usual magnetically tuned YIG oscillator because it can be set much faster. You notice it in particular when resetting the frequency between two frequency scans. The sweep oscillator is always synchronized to the reference frequency, which results in excellent frequency accuracy even with large spans. The minimum sweep time of FSP is 2.5 ms. Plus, the FSP synthesizer features extremely low phase noise. The guaranteed figure at 500 MHz and 10 kHz carrier offset is -106 dBc(1 Hz). Typically, a figure as low as -110 dBc(1 Hz) is obtained (FIG 2). These good phase noise characteristics are maintained up to 7 GHz input frequency because there is no doubling of the oscillator frequency.

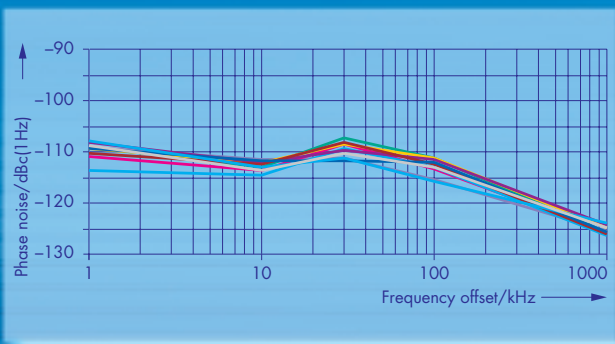

FIG 2 Phase noise of Spectrum Analyzer FSP at 500 MHz, measured on 10 units

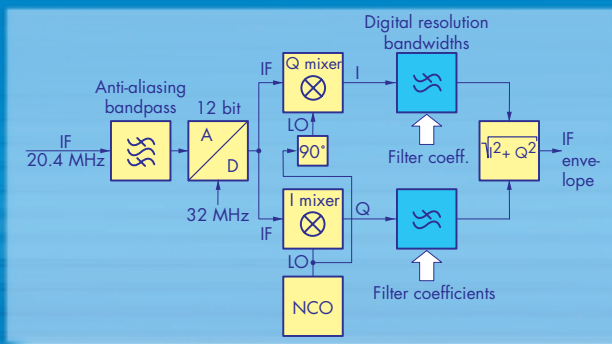

FIG 3 Block diagram of digital filters in FSP

Digital signal processing

Other important features contributing to the high measurement speed of FSP are the high sampling rate (32 MHz) for

the last IF voltage or video voltage, and processing of the digitized signals in R&S-developed ASICs. So sweep times between 1 μ s and 16 000 s are possible at zero span. This concept benefits not only measurement speed but also accuracy and reproducibility.

To maximize measurement speed and simplify manual operation, FSP features internal routines, running markedly faster using the internal sequences than with external control. Frequent measurements in development, verification and production are those of power and adjacent-channel power on TDMA or CDMA signals for example. Here FSP offers preconfigured, particularly fast test routines for the major standards (W-CDMA, cdmaOne, IS-136 and TETRA).

Digital resolution filters are implemented for bandwidths between 10 Hz and 30 kHz (FIG 3). Switchover between the filters is effected by loading the corresponding coefficients into the ASIC. This digital implementation of the IF bandwidths not only allows use of Gaussian filters, common in spectrum analyzers, but also of steep channel filters and even root-cosine filters, stipulated by different standards for measuring channel and adjacent-channel power.

The digital concept is utilized in FSP to measure adjacent-channel power in the time domain. The FSP family comes with channel filters for the most common standards, including W-CDMA. For power detection there is the rms detector familiar from the FSE family. FSP sets the different channel frequencies one after the other according to the selected standards, and measures the power at each frequency using the specified channel filters. Because of the fast VCO synthesizer, the time required for channel frequency switchover is virtually insignificant. Using this method, measurements are speeded up by a factor of about 10 compared to the integration method common to date in spectrum analyzers (FIG 4).

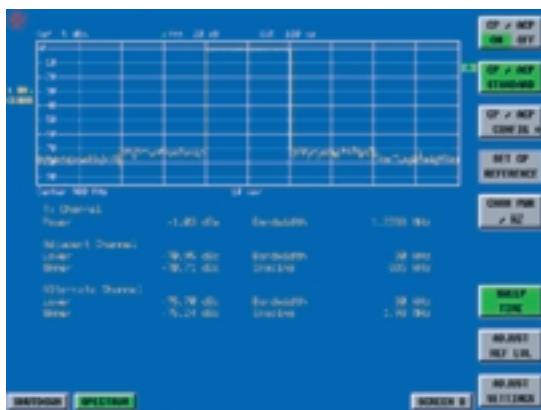

FIG 4 Adjacent-channel power measurement to IS-95 CDMA in time domain (Fast ACP). Measurements to this standard, for example, require a sweep time of approx. 800 ms when using the integration method so far common in spectrum analyzers, to be able to detect the power in the transmit channel and in two adjacent channels (above and below the transmit channel) with 0.25 dB standard deviation. Using the measurement method of FSP in the time domain, only 50 ms is required. Time overheads caused by frequency switchover, internal calculations and output of results via IEC/IEEE bus are only approx. 30 ms, so reproducible results are available within 80 ms.

Photo 43 389/10



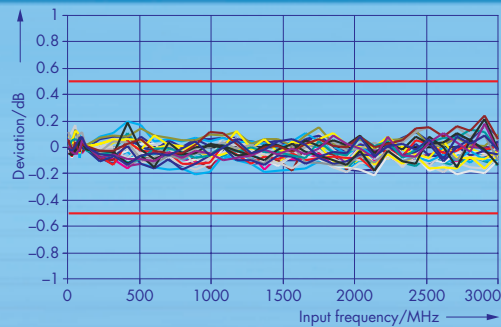

FIG 5 Frequency response of FSP up to 3 GHz, measured on 10 units at 0/25/50°C. Red tolerance lines mark guaranteed limit values specified in data sheet. Calculated standard deviation of results is 0.135 dB

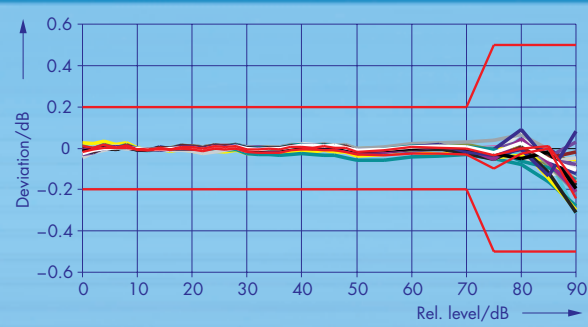

FIG 6 Linearity error of digital bandwidth filters between 10 Hz and 30 kHz in level range down to 90 dB below reference level, measured on 30 units. Red tolerance lines mark data sheet specifications (± 0.2 dB down to -70 dB and ± 0.5 dB below)

Measurement uncertainty reduced to a minimum

In FSP, Rohde&Schwarz presents for the first time a spectrum analyzer with a guaranteed total measurement uncertainty as small as 0.5 dB in the main communication range up to 3 GHz, and this over the specified temperature range, for all RF attenuator settings and with 70 dB level range on the display.

Due to the high measurement accuracy of FSP, higher tolerances can be allowed for the DUT and the number of rejects reduced, or measurement times can be reduced with correspondingly lower repeat accuracy.

The outstanding precision of FSP is based on a concept that minimizes uncertainties right from the start:

- digital signal processing in ASICs,
- use of function modules with close tolerances, which are decisive for measurement uncertainties,
- correction of residual errors by integrated firmware.

To make it easier for the user to calculate the total measurement uncertainty, for example in a test system, the FSP data sheet for the first time specifies standard deviations of the individual uncertainties (FIGs 5 and 6).

Excellent RF performance

The RF performance of an analyzer is a decisive criterion as to whether complex measurements, for example of intermodulation or spurious, can be performed for a given DUT. Depending on the demands made for RF performance, a high-end spectrum analyzer like FSE or a medium-class instrument like FSP will be used. While FSP is not comparable with FSE or FSIQ in terms of RF performance, it excels in sensitivity and large-signal characteristics for an instrument of the medium class.

Sensitivity is usually specified as displayed average noise level (DANL) at the smallest resolution bandwidth. FSP achieves < -140 dBm at 10 Hz resolution bandwidth up to 7 GHz. Typical figures are -145 dBm (10 Hz) up to 3 GHz and -143 dBm (10 Hz) from 3 GHz to 7 GHz. The FFT filters (1 Hz to 30 kHz) fitted as standard not only improve DANL but also afford considerably higher speed than sweep filters.

But overall dynamic range is determined by DANL plus large-signal characteristics. The latter depend on the power-handling capacity of the input mixer (1 dB compression) and on intermodulation. With a 1 dB compression

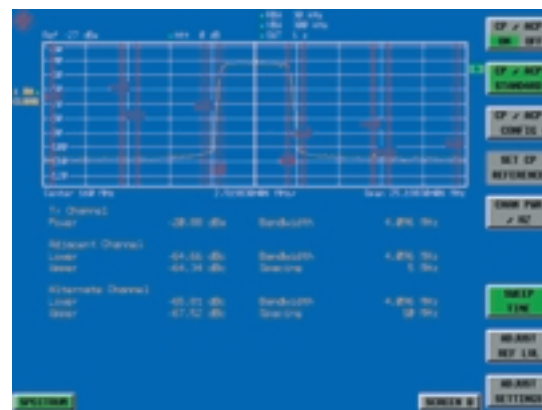

FIG 8 Adjacent-channel power measurement on W-CDMA uplink signal shows the excellent overall dynamic range of about 64 dBc of Spectrum Analyzer FSP

level of the input mixer of 0 dBm and a third-order intercept point of ≥ 7 dBm, FSP offers an overall dynamic range that is excellent in this medium class (FIG 7).

The outstanding dynamic characteristics show, for example, in adjacent-channel power measurements on uplink W-CDMA signals to ARIB standard with an overall dynamic range of approx. 64 dBc in the first adjacent channel (FIG 8).

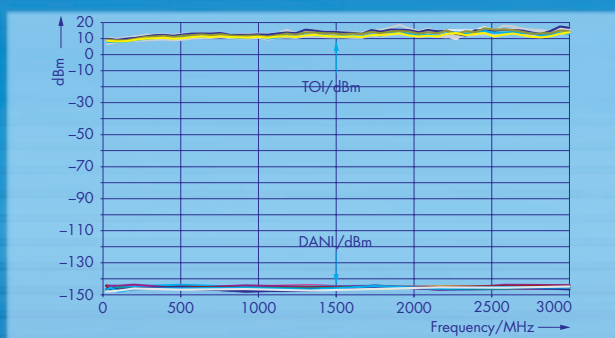

Photo 43 389/12

FIG 7 Displayed average noise level (DANL) at 10 Hz bandwidth and third-order intercept point (TOI) measured on 10 FSP3 units

Multitude of preconfigured measurement functions

The FSP family comes with a large number of preconfigured measurement functions for the wide range of applications to be covered by a spectrum analyzer (yellow box). With so many functions ready implemented, FSP's list of options is very short. An OCXO is available for enhanced frequency accuracy, a tracking generator for scalar network analysis up to 3 GHz, and an AM/FM demodulator with internal loudspeaker and headphones output for signal monitoring. The optional

100-base T-LAN interface allows not only networked control of FSP but also transfer of large amounts of data from FSP's IQ memory (2 x 128 kwords). Noise Measurement Software FS-K3 is available for measuring the noise figure of amplifiers and frequency-converting components and modules. The noise source is driven direct by FSP.

Josef Wolf

REFERENCES

- [1] Wolf, Josef: Spectrum Analyzer FSEA/FSEB: New dimensions in spectral analysis. News from Rohde & Schwarz (1995) No.148, pp 4-8

Condensed data of FSP

Frequency range (FSP3/7/13/30)	9 kHz to 3/7/13/30 GHz
Amplitude measurement range	-140 dBm to 30 dBm
Amplitude display range	10 dB to 200 dB in steps of 10 dB, linear
Amplitude measurement error limit	<0.5 dB up to 3 GHz <2 dB from 3 GHz to 13 GHz <2.5 dB from 13 GHz to 30 GHz
Resolution bandwidths	1 Hz to 30 kHz, FFT filters 10 Hz to 10 MHz in increments of 1 and 3 EMI bandwidths 200 Hz, 9 kHz, 120 kHz, channel filters
Detectors	max peak, min peak, auto peak, sample, average, rms, quasi-peak
Display	21 cm (8.4") TFT colour LC display, VGA resolution
Remote control	IEC 625-2 (SCPI 1997.0) or RS-232-C
Dimensions (W x H x D)	412 mm x 197 mm x 417 mm
Weight w/o options (FSP3/7/13/30)	10.5/11.3/12/12 kg

Reader service card 166/01

Preconfigured test functions

- Frequency counter with fast algorithm for digitally implemented bandwidths up to 30 kHz
- Measurement of noise and phase noise
- Measurement of AM modulation depth
- Measurement of third-order intercept point (TOI)
- Power measurement in time domain (mean, rms and peak power over selectable time periods)
- Power measurement in frequency domain, adjacent-channel power measurement preconfigured for major standards
- Gated-sweep function
- Versatile trigger functions (free run, video, external, IF power, pretrigger, trigger delay)
- Signal statistics (APD/CCDF) over definable number of decorrelated measured values
- Measurement of occupied bandwidth
- EMI quasi-peak detector (bands A, B and C/D) with corresponding EMI bandwidths 200 Hz, 9 kHz and 120 kHz
- User-definable limit lines (absolute or relative) with selectable margin and pass/fail indication
- Two independent test settings with fast switchover at keystroke
- Split-screen display with separate settings in two measurement windows